

ESENA

1D1W

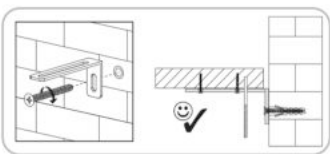

Ø5
Ø8

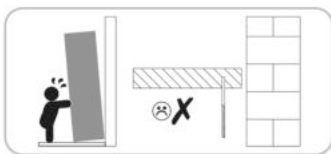
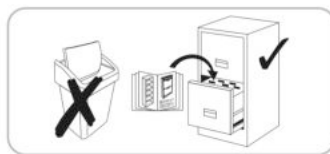
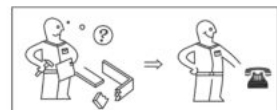
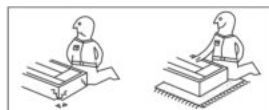
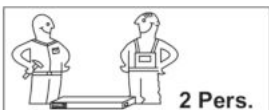
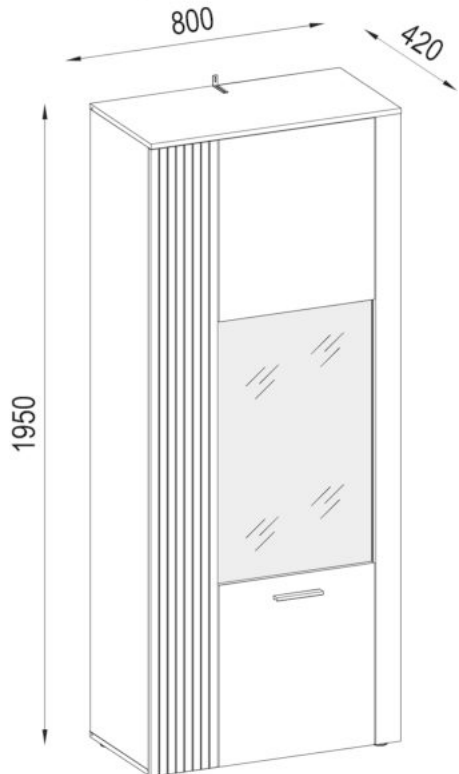
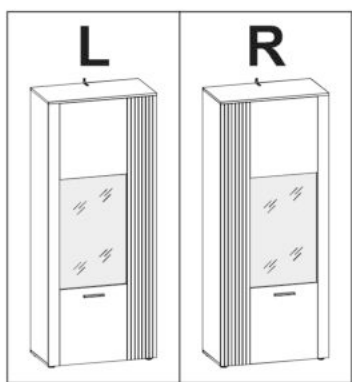

utáhnout



stlačit



změřit



stisknout



zatlouct



otočit - obrátit

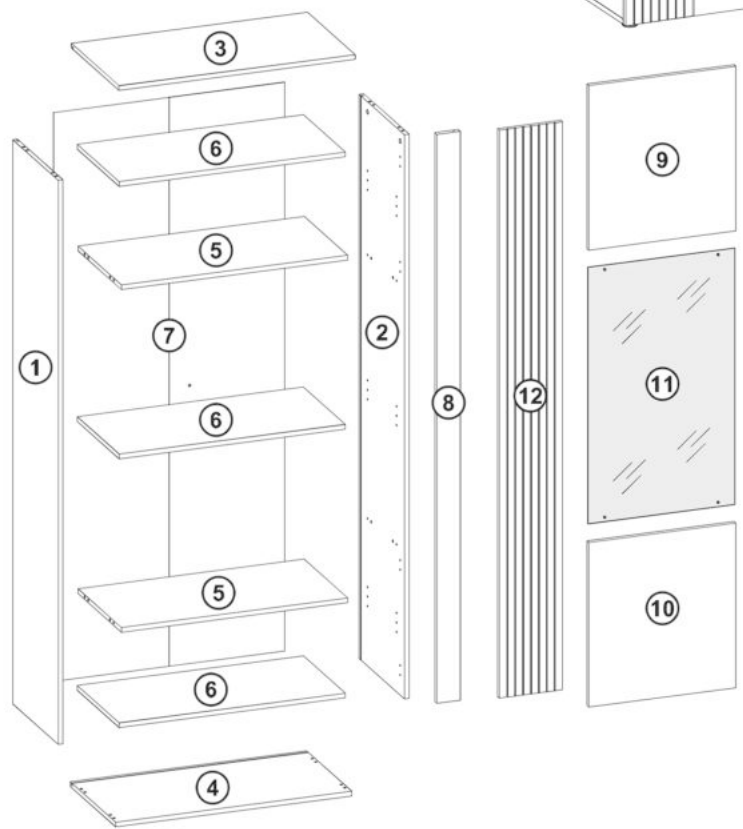





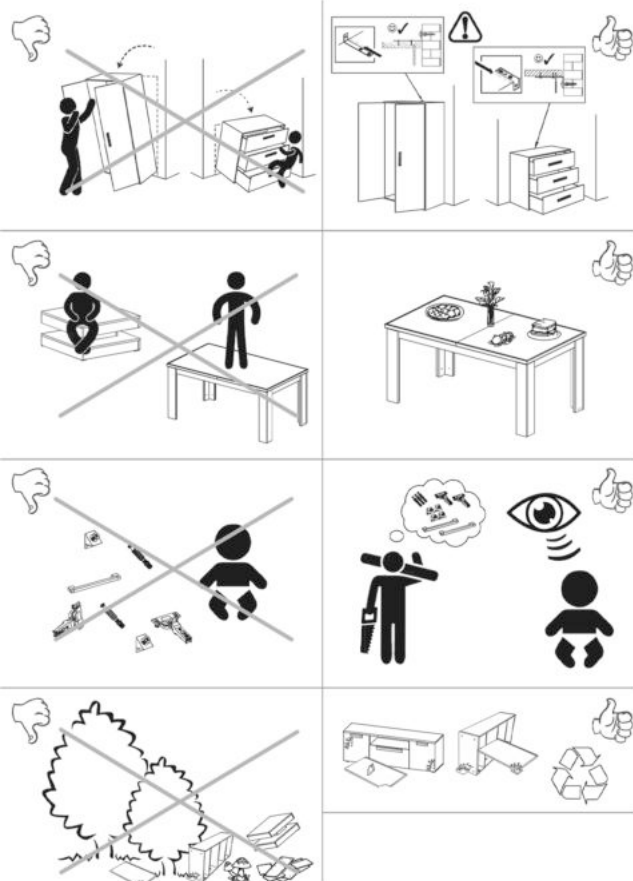







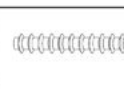







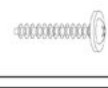
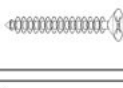

A	B (mm)		C	D
1	1898	400	16	x1 2/2
2	1898	400	16	x1 2/2
3	800	420	16	x1 1/2
4	800	400	16	x1 1/2
5	766	384	16	x2 1/2
6	766	370	16	x3 1/2
7	1914	782	2,5	x1 2/2

A	B (mm)		C	D
8	1914	80	18	x1 2/2
9	554	498	16	x1 2/2
10	554	498	16	x1 2/2
11	863	498	4	x1 2/2
12	1911	214	16	x1 2/2
B1				1/2



B1 1/2

A1 15x12  x12	C2 44mm  x12	B2 8x30  x16
FA1 4mm  x1	F3 6,3x50  x4	O3 Ø18  x8
K6 Ø35  x4	J65 128/148  x1	O4 Ø18  x4
M1 10x10x15  x14	P14 45x20  x4	N1 Ø6  x12
Y36 75x32x15  x1	N5 10x6x10  x4	DB2 4x25  x2
D25 4x25  x4	Y37 8x50  x1	Y35 4,2x65  x1
DA21 4,2x16  x24	D11 3,5x16  x18	R10 Ø10  x4
T1 30x35x55  x4	K9 Ø35  x4	O5 Ø8  x2

Náš nábytek se musí používat podle předpisů. Používání v rozporu s předpisy může vést k věcným škodám a za jistých okolností také k zraněním osob. Nábytek není hračka. Za škody, které vzniknou používáním proti předpisům nebo nesprávnou manipulací, nepřijímá výrobce nebo prodejce žádnou zodpovědnost.

POZOR: Děti nebo osoby s mentálním postižením se musí neustále držet mimo díly nábytku, špičatých předmětů, drobných částí a obalových materiálů, protože hrozí riziko zranění a/nebo udušení.

MONTÁŽ: Při montáži dodržujte náš návod k používání, obsluze, instalaci nebo montáži a dávejte hlavně pozor na výstražné a bezpečnostní pokyny. Pokud se nebudou dodržovat předpisy, může to mít za následek zranění osob nebo poškození nábytku / ohrožení bezpečnosti. Pokud byste měli potíže s instalací/montáží, kontaktujte náš servisní tým. Tento vám ochotně poradí a pomůže. Montáž smí provádět pouze kvalifikovaný personál. Při změnách na produktu/dílechproduktu, při výměně nebo použití dílů/spotřebních materiálů, které nepocházejí od výrobce/prodejce, nepřijímáme žádnou odpovědnost za škody.

Pokud jsou ke zboží přiloženy upevňovací prvky na zeď, jako jsou hmoždinky a šrouby, jsou tyto určeny výhradně pro použití na stěnách z pevných a jedolitých materiálů. Upevnění je jen tak dobré, jak dobré je spojení mezi upevňovacím prostředkem a stěnou. Před upevněním musíte zkontrolovat vhodnost vaší stěny pro stojící i závěsný nábytek a použít pouze vhodné spojovací prvky. Před případným vrtáním se ujistěte, že se v oblasti vrtání nenachází elektrické vodiče. Nakonec je za upevnění na stěnu odpovědný instalační technik.

Platí to také pro instalaci elektrických produktů a dalšího stavebně-technického příslušenství. Montáž/instalaci elektrických produktů a také dalšího důležitého konstrukčního příslušenství může provádět pouze autorizovaný kvalifikovaný personál. Veškeré elektrické a stavebně-technické instalace musí být provedeny v souladu s platnými normami a bezpečnostními předpisy ve vaší zemi. Pro světelné zdroje používejte pouze povolenou intenzitu osvětlení. Při nedodržení max. počtu Watt hrozí riziko požáru v důsledku přehřátí. Překrývání svítidel není povoleno z důvodu rizika požáru.

Dokonale funkce nábytku je zaručena pouze při vertikální a horizontální instalaci. Dveře jsou předem nastavené, mohou se ale znovu seřadit/nastavit na základě místních podmínek. Dodržujte údaje o hmotnostní pro maximální zatížení. Na nábytek se nesmí lézt. Při neodborném použití může dojít k převrácení nábytku. Aby se tomu zamezilo, musí být nábytek neustále zajištěn proti převrácení. Při přetížení/nadměrném přetížení (zejména hračkami, lidmi, materiálem nebo jinými nevhodnými vlivy) hrozí riziko rozbití a zranění. Všechny šrouby a nosná spojovací místa by měla být dotazena po 5 až 6 týdnech, aby se zajistila trvalá stabilita.

PÉČE:

-Pokyny k péči o nábytek-

Dodržujte naše pokyny pro správnou péči o nábytek, abyste si náš výrobek mohli užívat co nejdéle. Při čištění používejte čistý, suchý a měkký bavlněný hadřík. Pokud potřebuje váš nábytek důkladné vyčištění, můžete hadřík navlhčit trochou vody nebo čisticího prostředku na nábytek a pak vyčištěné věci vysušit. Kovové a skleněné díly se nejlépe čistí běžně dostupnými čisticími prostředky na kovy a sklo podle pokynů, které jsou na nich uvedené. Na čisticích prostředcích musí být jasně uvedeno, že jsou vhodné k čištění nábytku.

V žádném případě nepoužívejte parní čističe, žíraviny, abraziva nebo jiné prostředky, jejichž účinky neznáte. **POZOR:** Vysoce lesklé povrchy jsou při dodávce chráněny ochrannou fólií. Nechte fólii na nábytku, dokud nebude zcela smontován a zbaven prachu. Vysoce lesklé prvky, ze kterých byla odstraněna ochranná fólie, lze čistit a používat až po 72 hodinách (doba pro následné vytvrzení na okolním vzduchu). Povrchy nelze poškodit ostrými předměty a nikdy je nemůžete vystavovat silnému slunečnímu záření.

LIKVIDACE



-Pokyny k likvidaci odpadu-

V zájmu ochrany životního prostředí vyhazujte obalový odpad rozříděný podle druhu do určených odpadkových/recyklačních nádob, v žádném případě nevyhazujte do přírody. Poškozený nebo nepoužitelný nábytek lze odeslat do speciálních sběrných zařízení k recyklaci jednotlivých dílů. Používaný, ale stále funkční nábytek není nutné hned likvidovat. Darujte je např. charitativním organizacím.

Přejeme vám mnoho zábavy s vašim novým nábytkem.

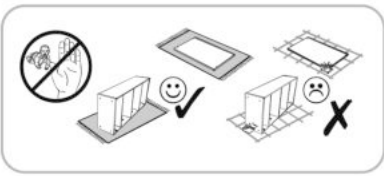
1



- A1** 15x12  x4
- C2** 44mm  x8
- B2** 8x30  x8

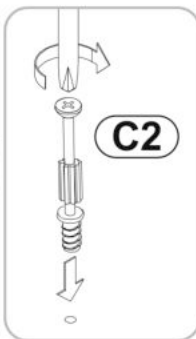
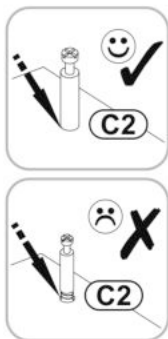
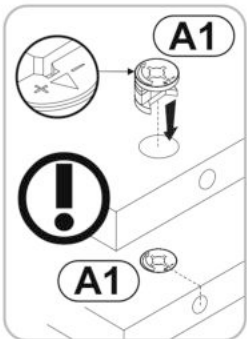
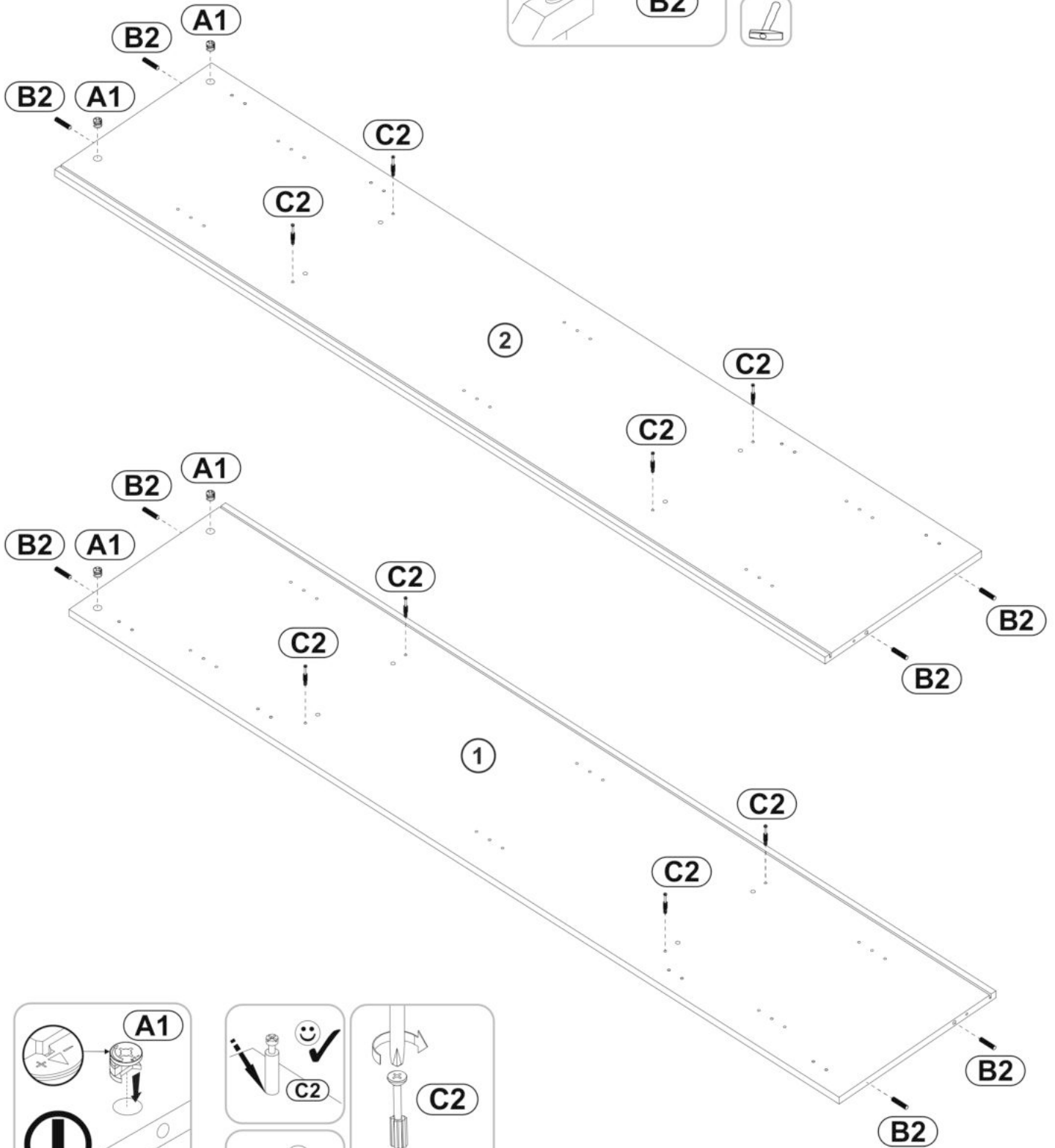
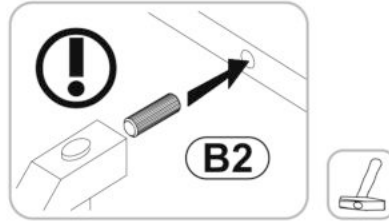

2

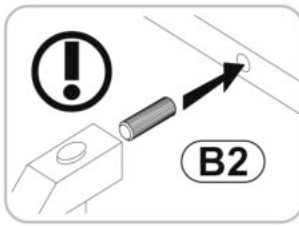
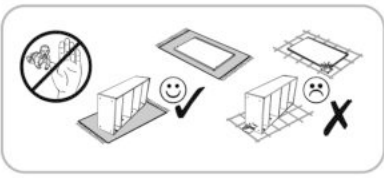

A1		x8
15x12		
C2		x4
44mm		
B2		x8
8x30		

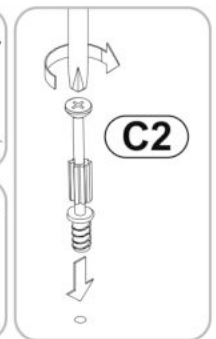
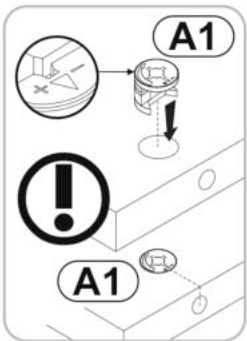
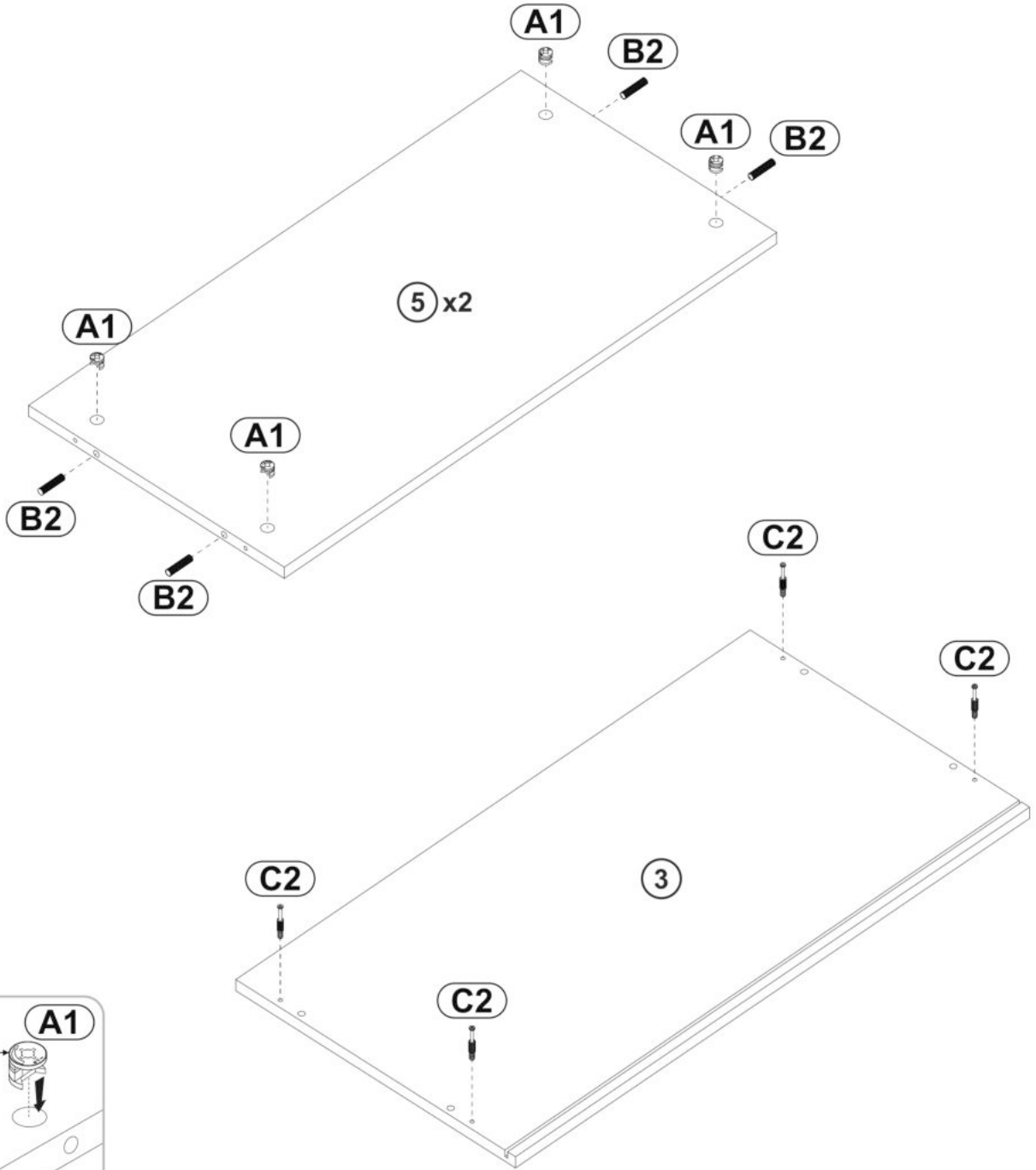

3

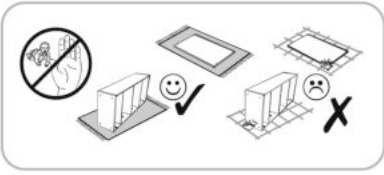

DA21
4,2x16  x8

T1
30x35x55  x4

K9
Ø35  x4

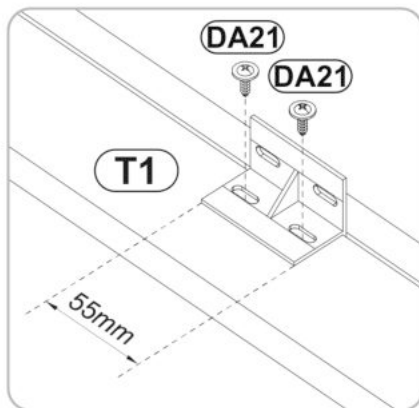
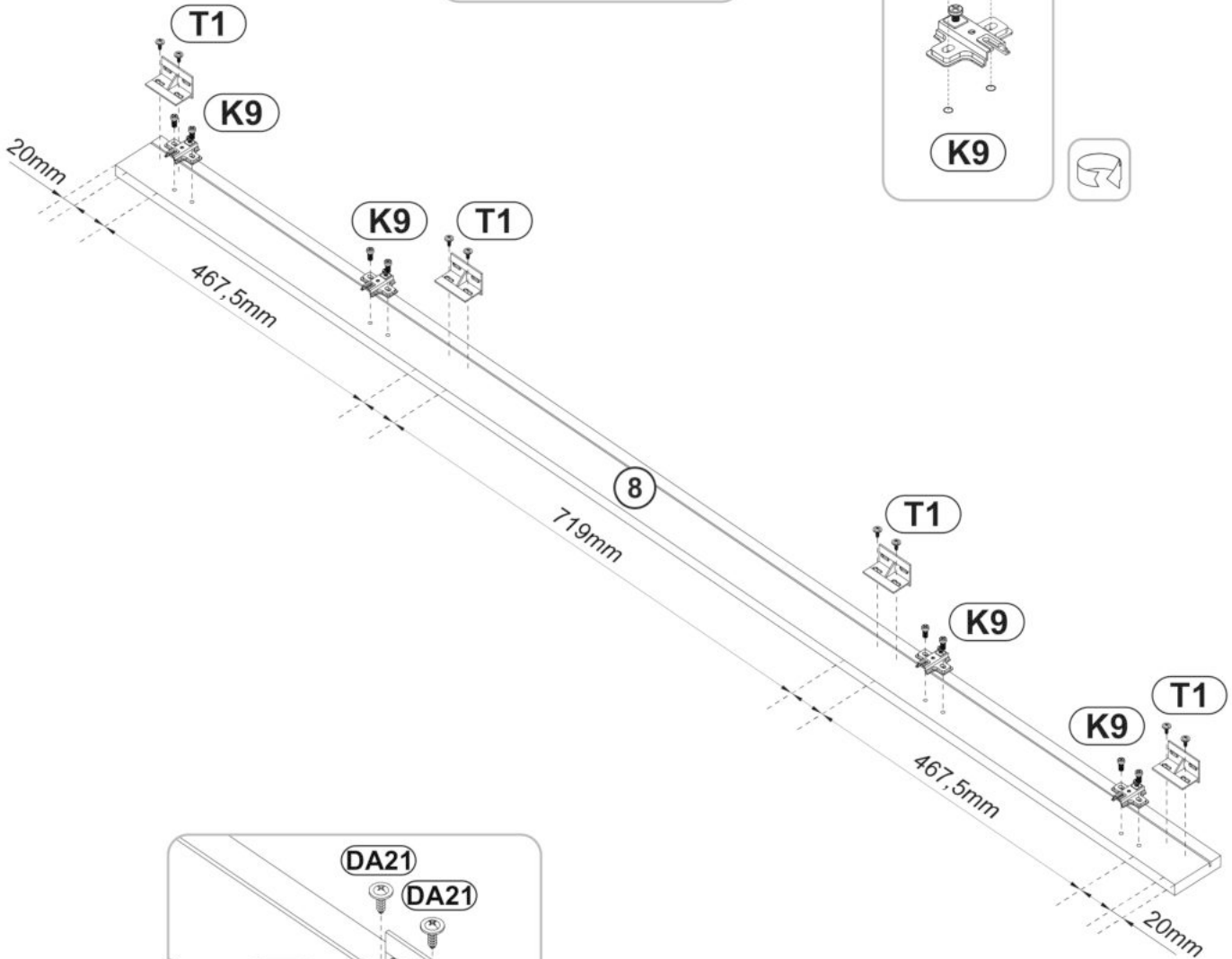
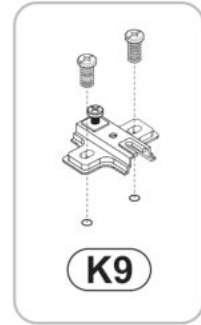
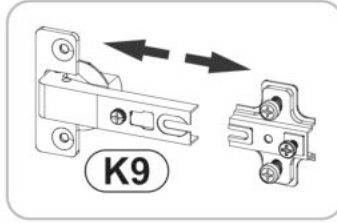

4

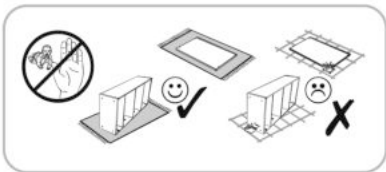

O3
Ø18 x8

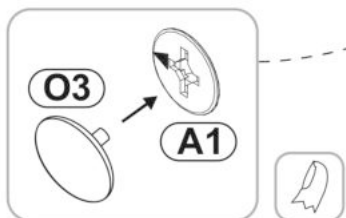
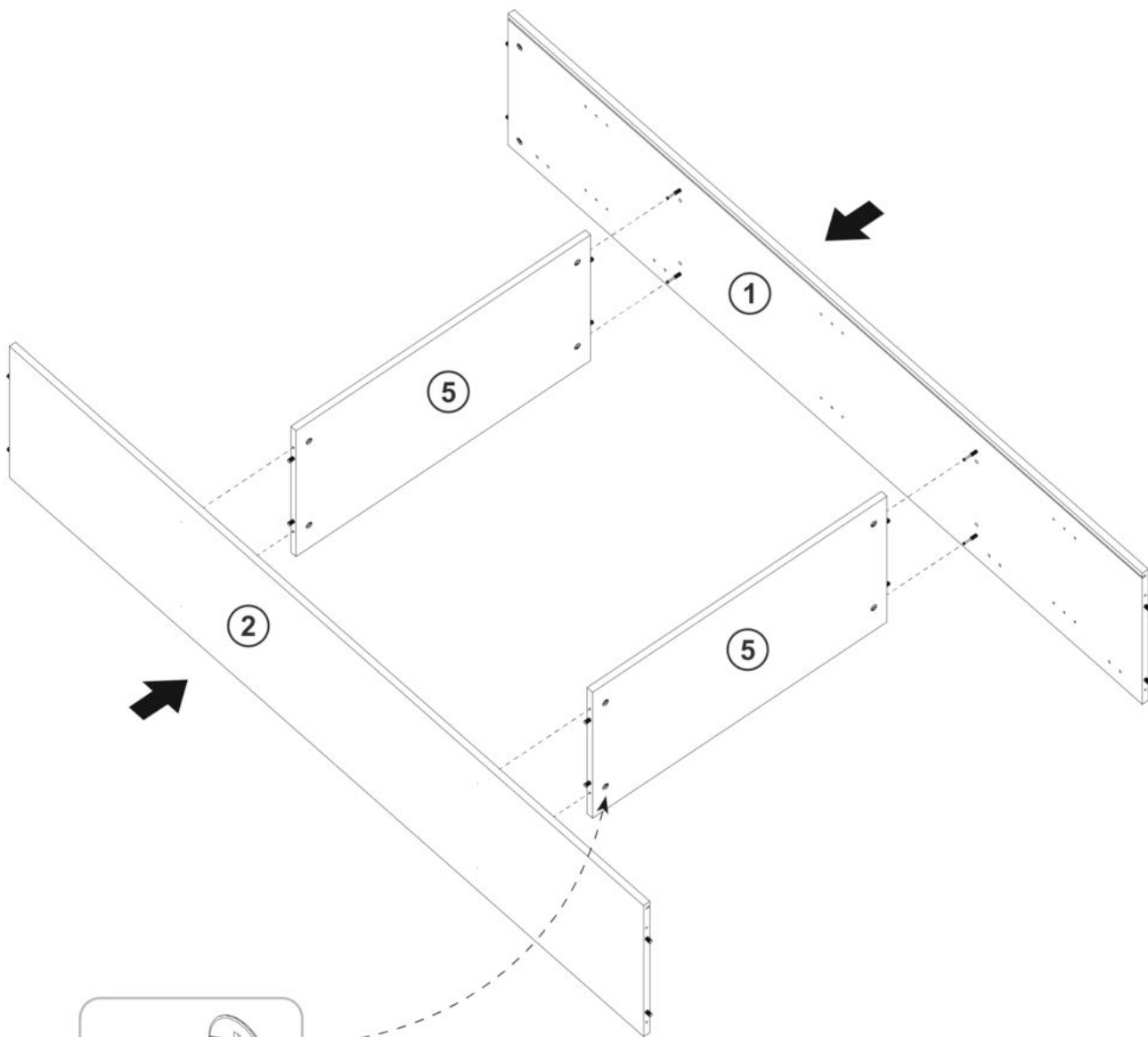
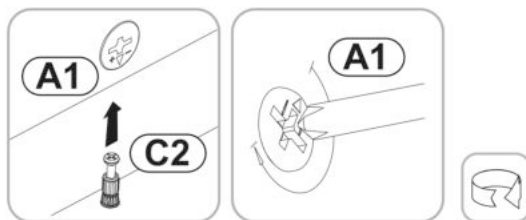

5

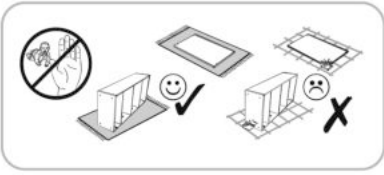

O4  **x4**
Ø18

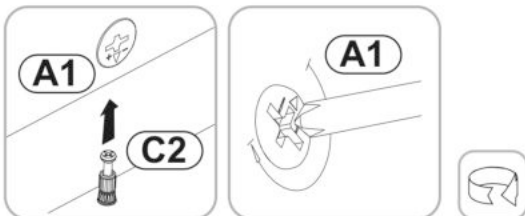
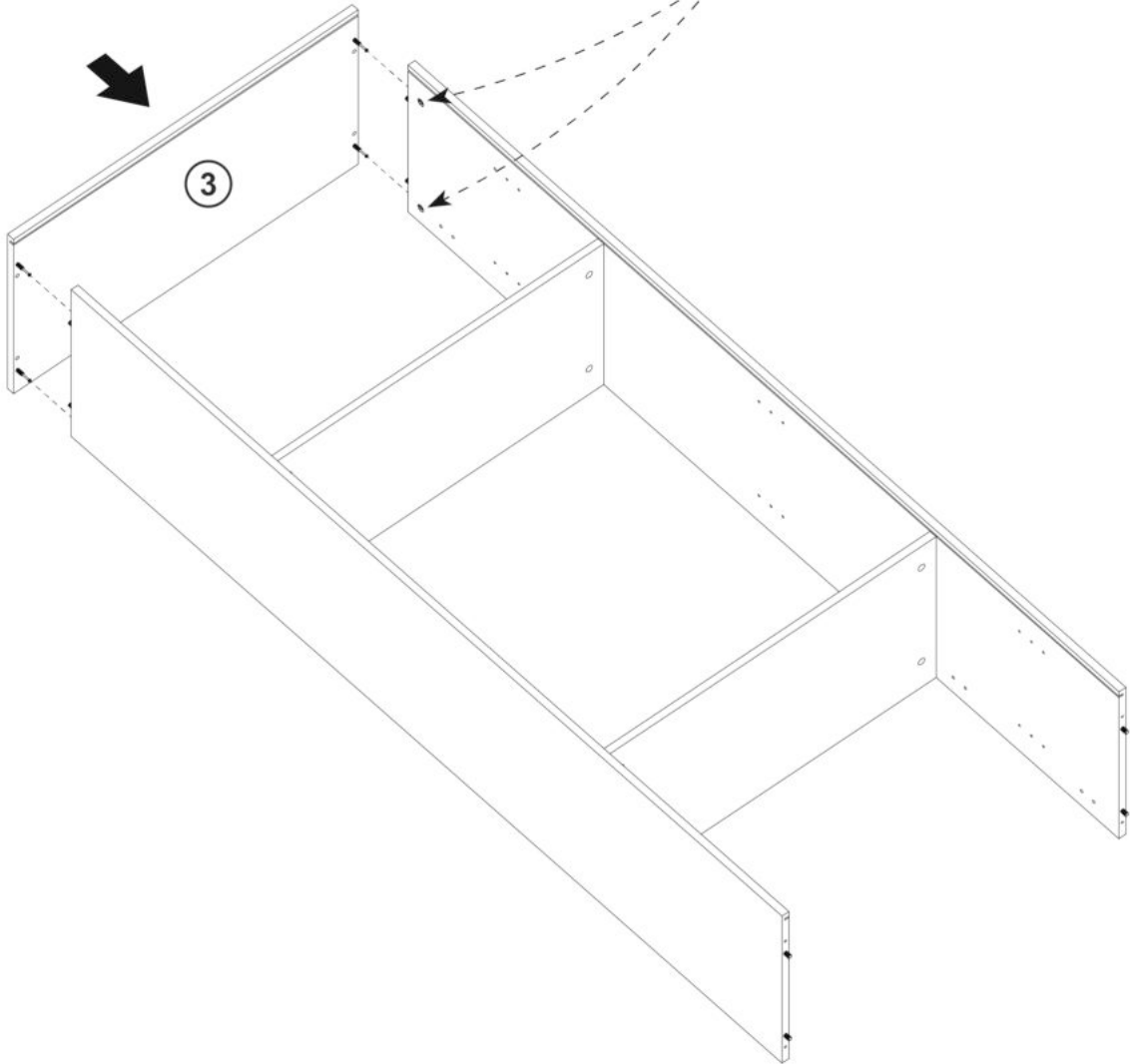
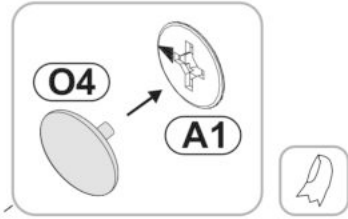

6

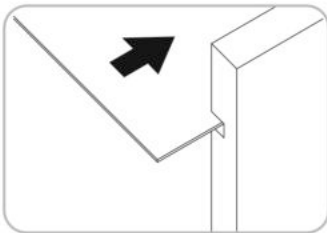
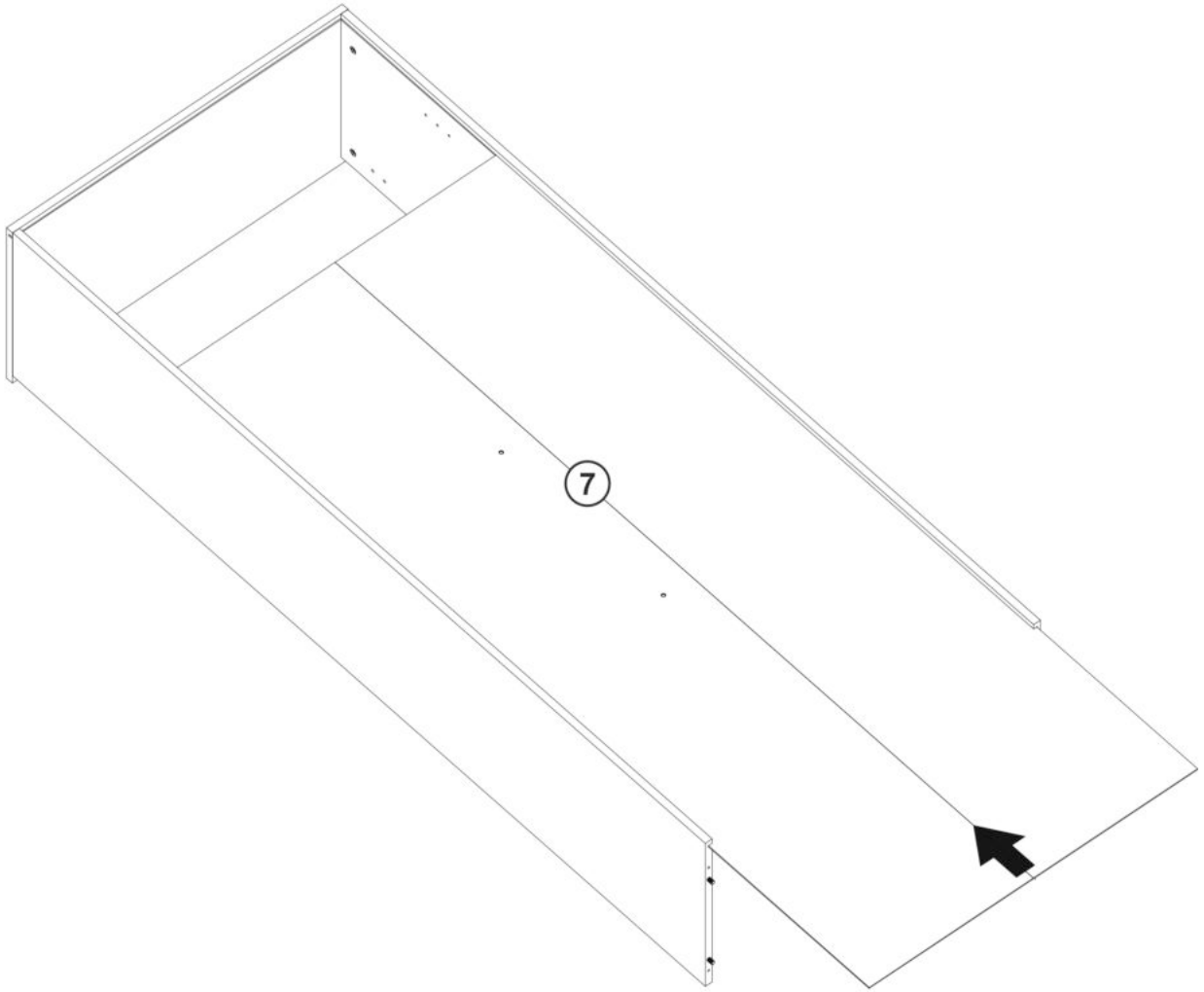
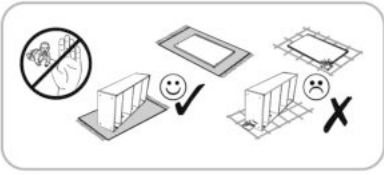

7

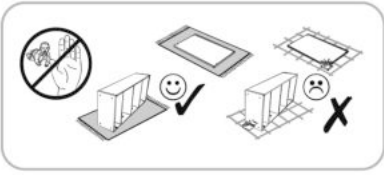

FA1
4mm x1

F3
6,3x50 x4

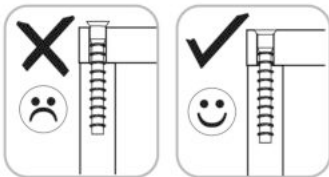
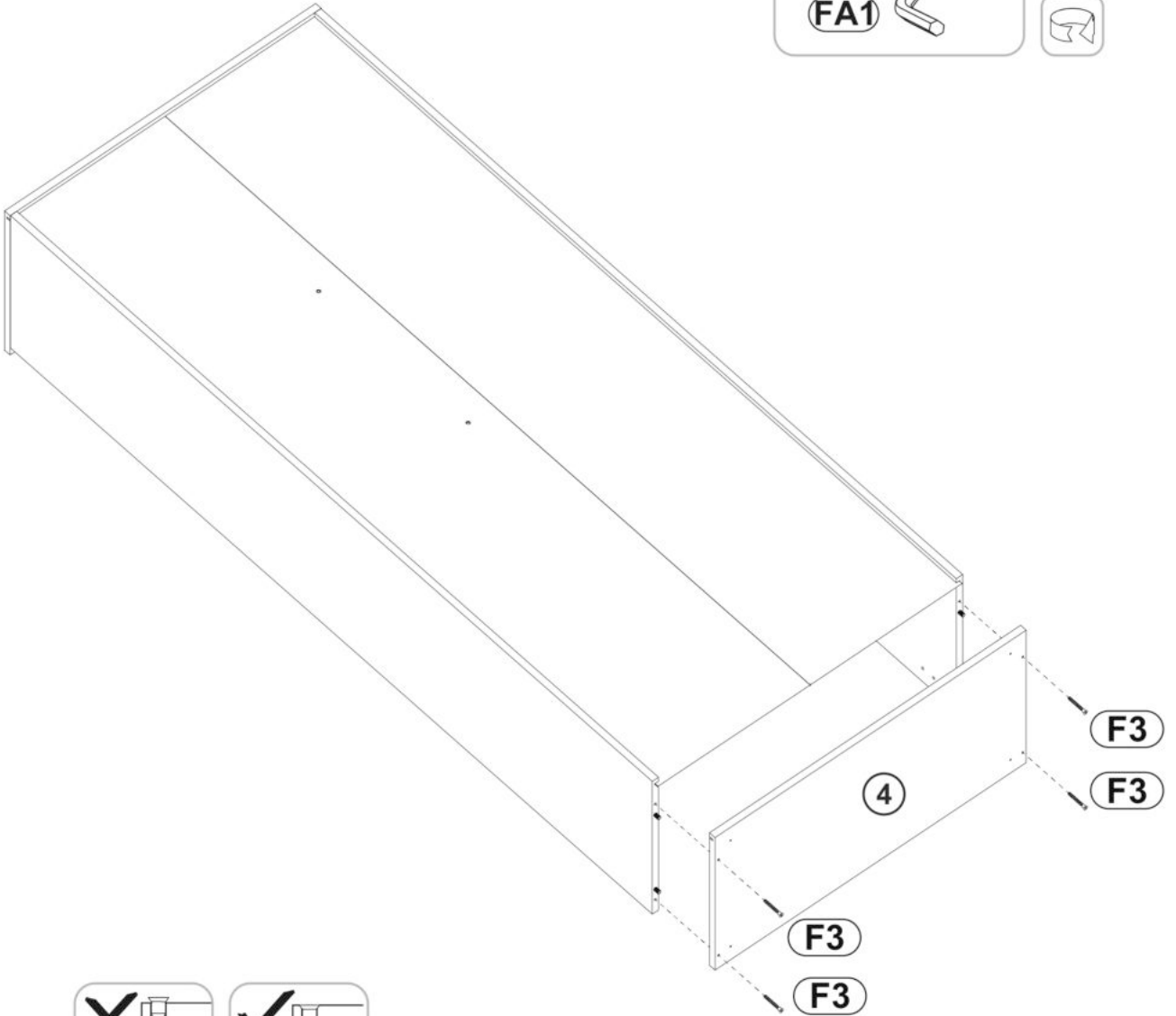
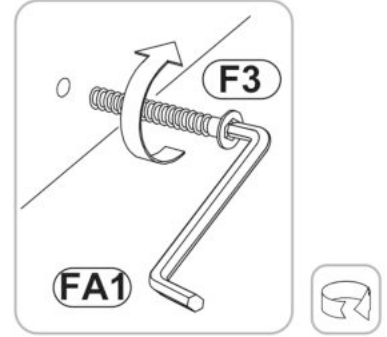

8

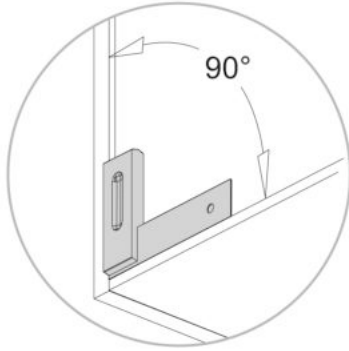
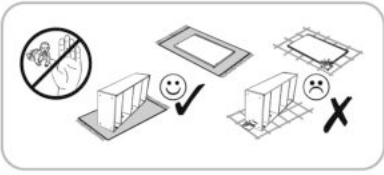

A=B

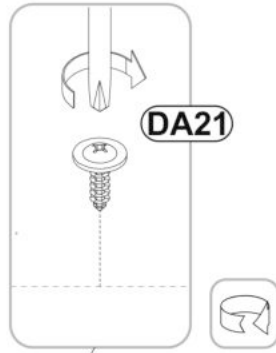

DA21

M1
10x10x15 x14

DA21
4,2x16 x4

P14
45x20 x4

D25
4x25 x4

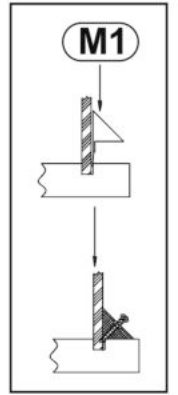
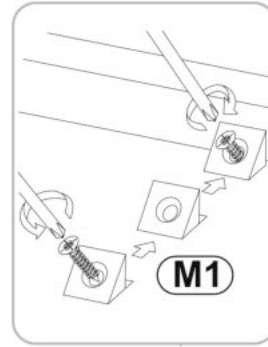

M1

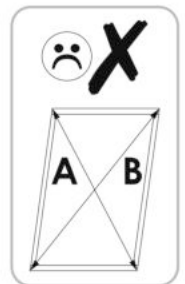
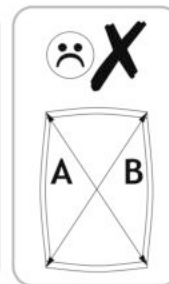
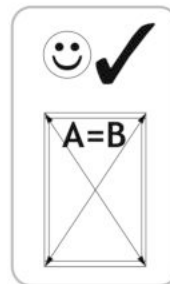
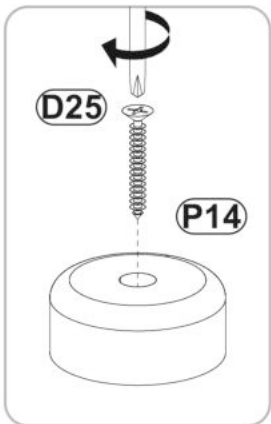
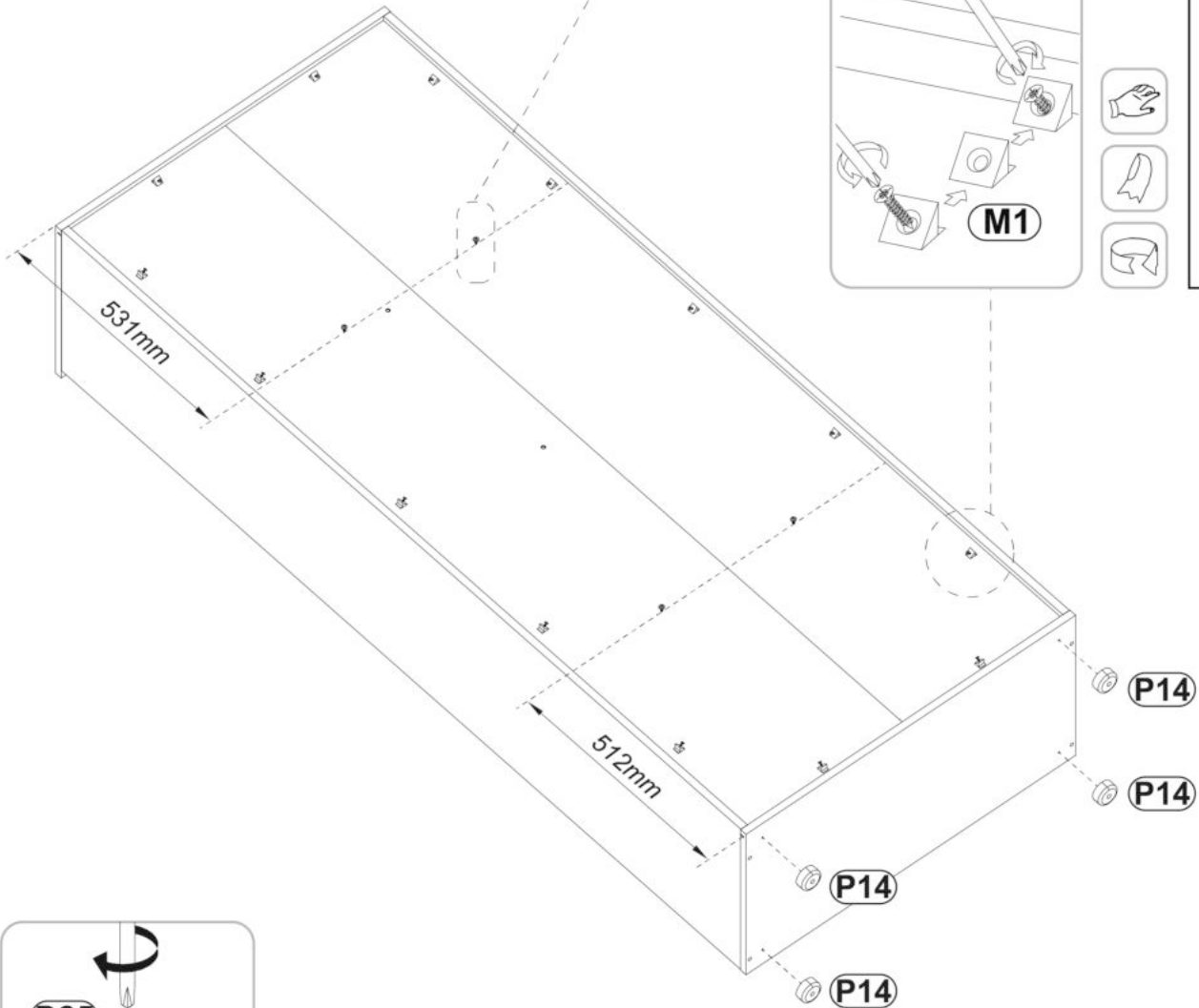

9

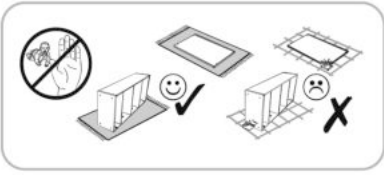

N1
Ø6 x12

O5
Ø8 x2

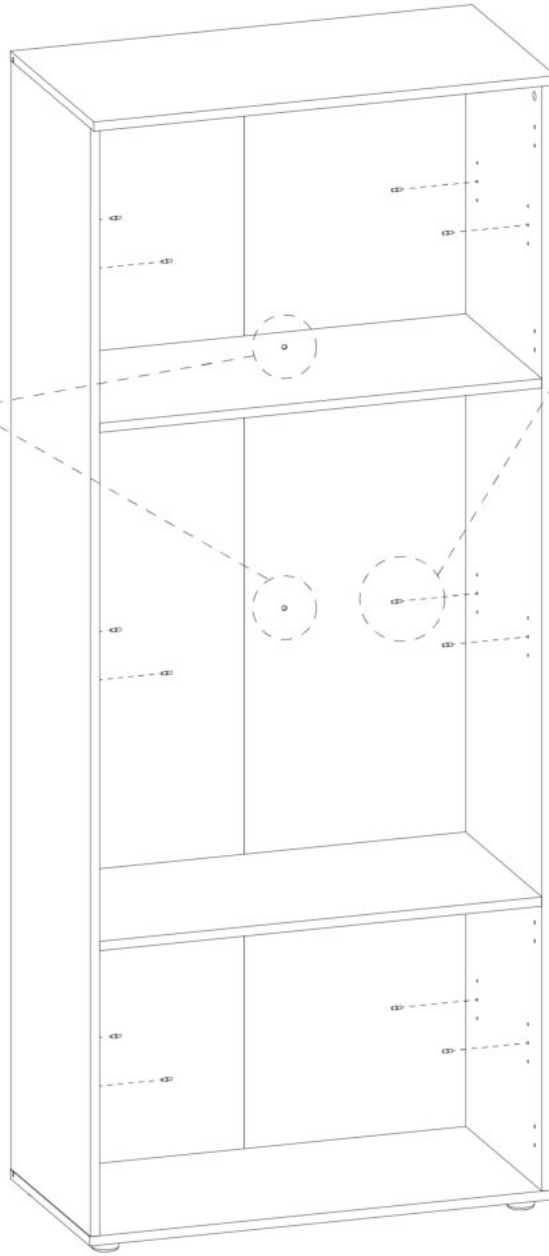
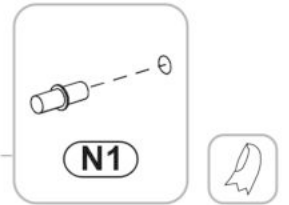
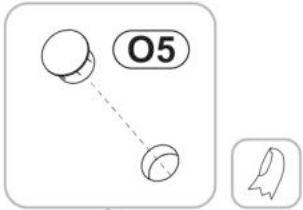

10

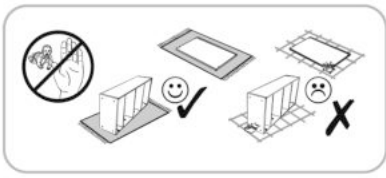

Y36
75x32x15 x1

Y37
8x50 x1

D11
3,5x16 x2

Y35
4,2x65 x1

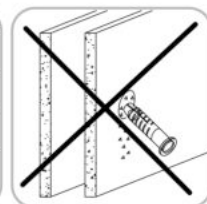
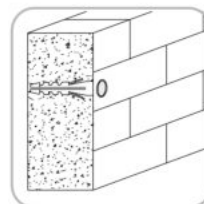
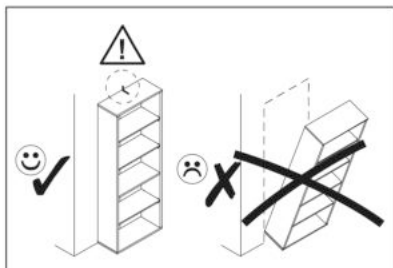
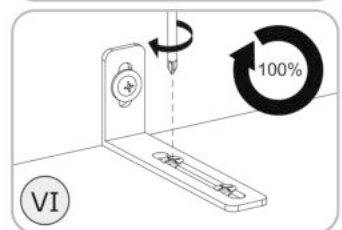
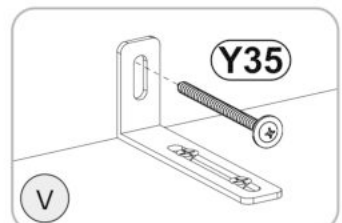
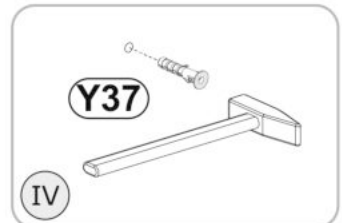
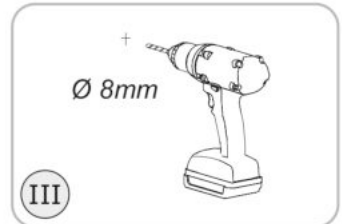
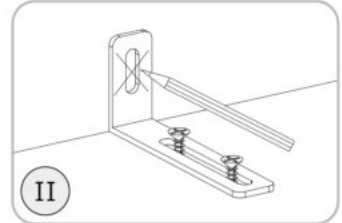
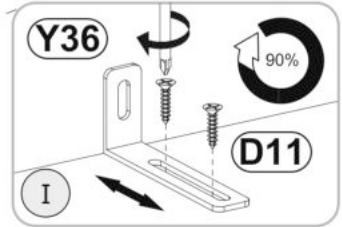
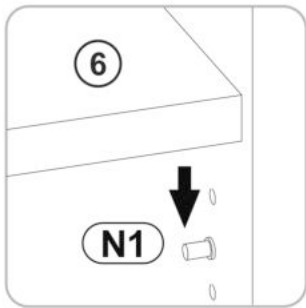
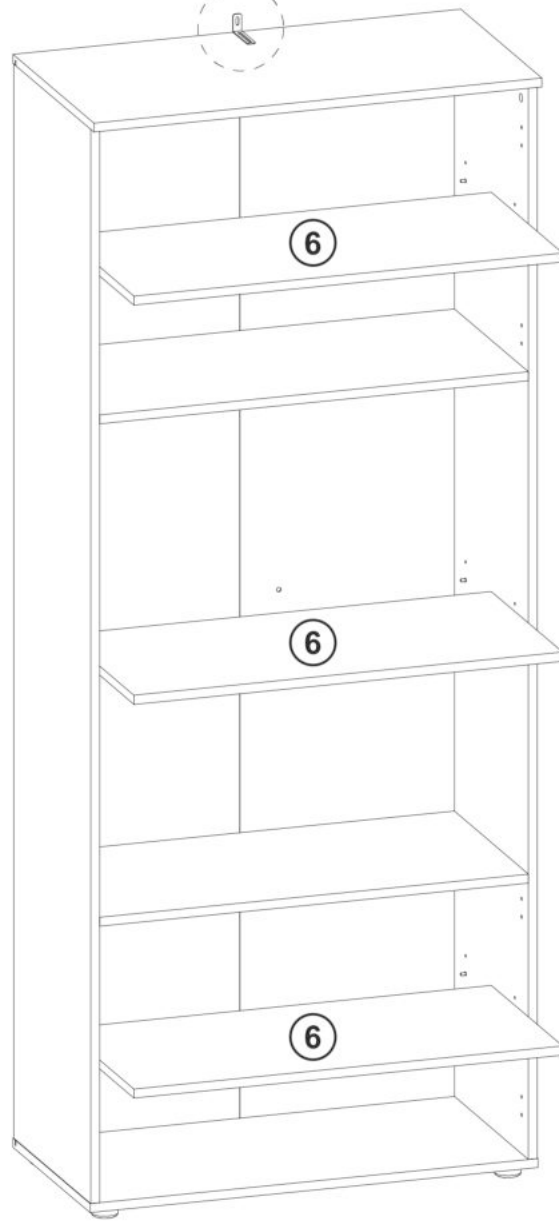

11

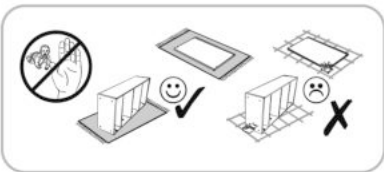

K6  **x4**
Ø35

D11  **x8**
3,5x16

R10  **x2**
Ø10

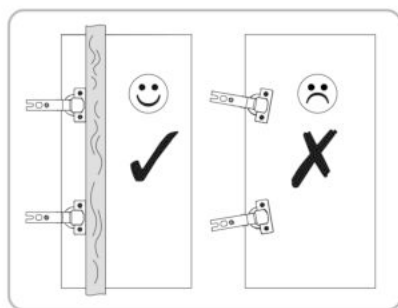
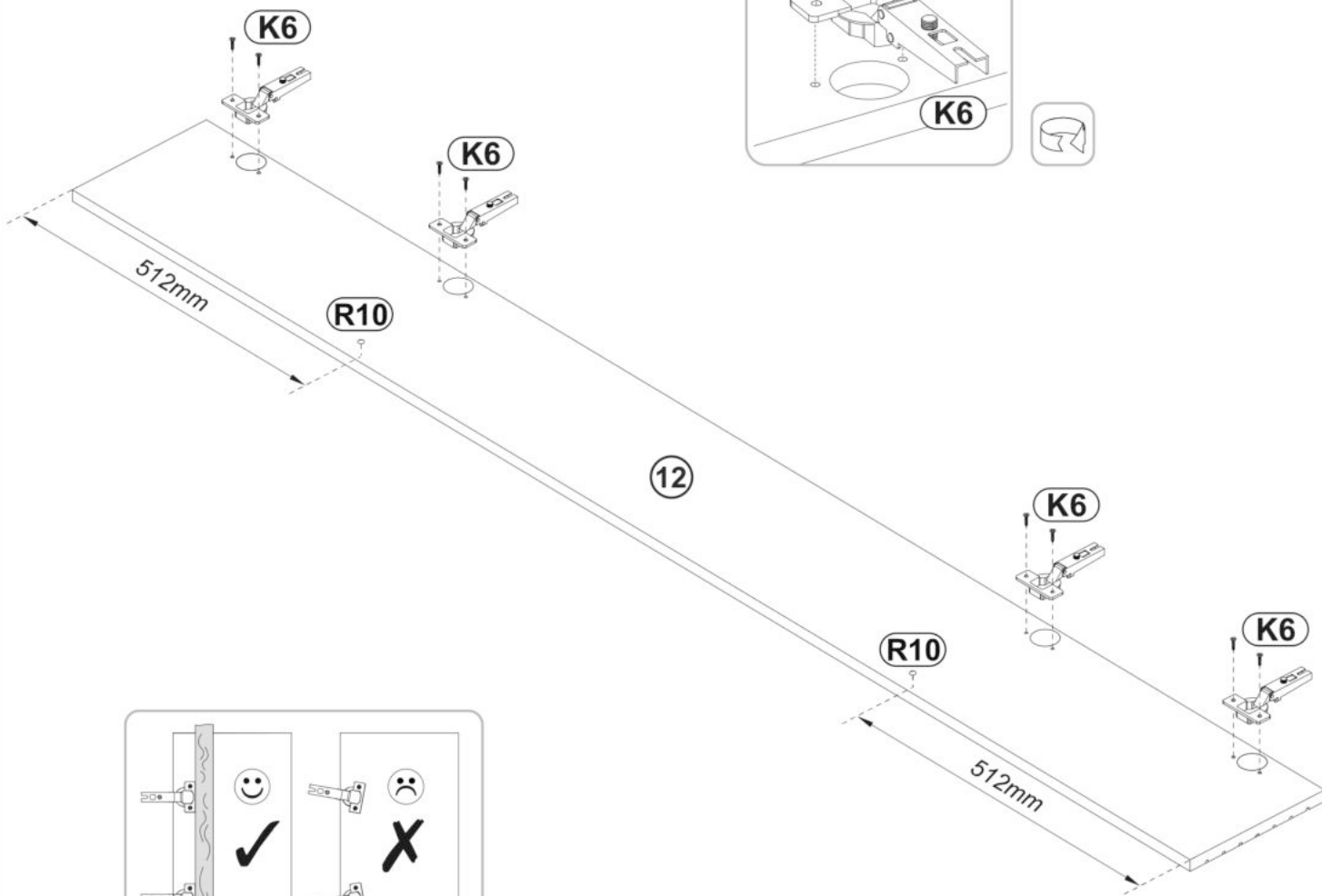
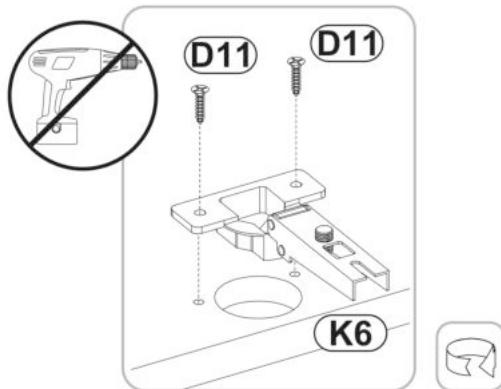

12

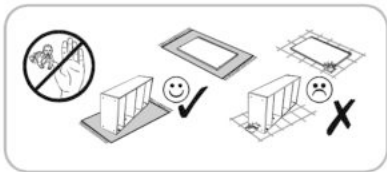

N5
10x6x10  x4

DA21
4,2x16  x4

R10
Ø10  x2

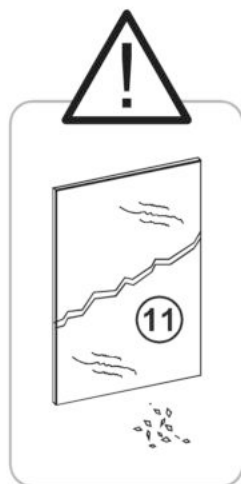
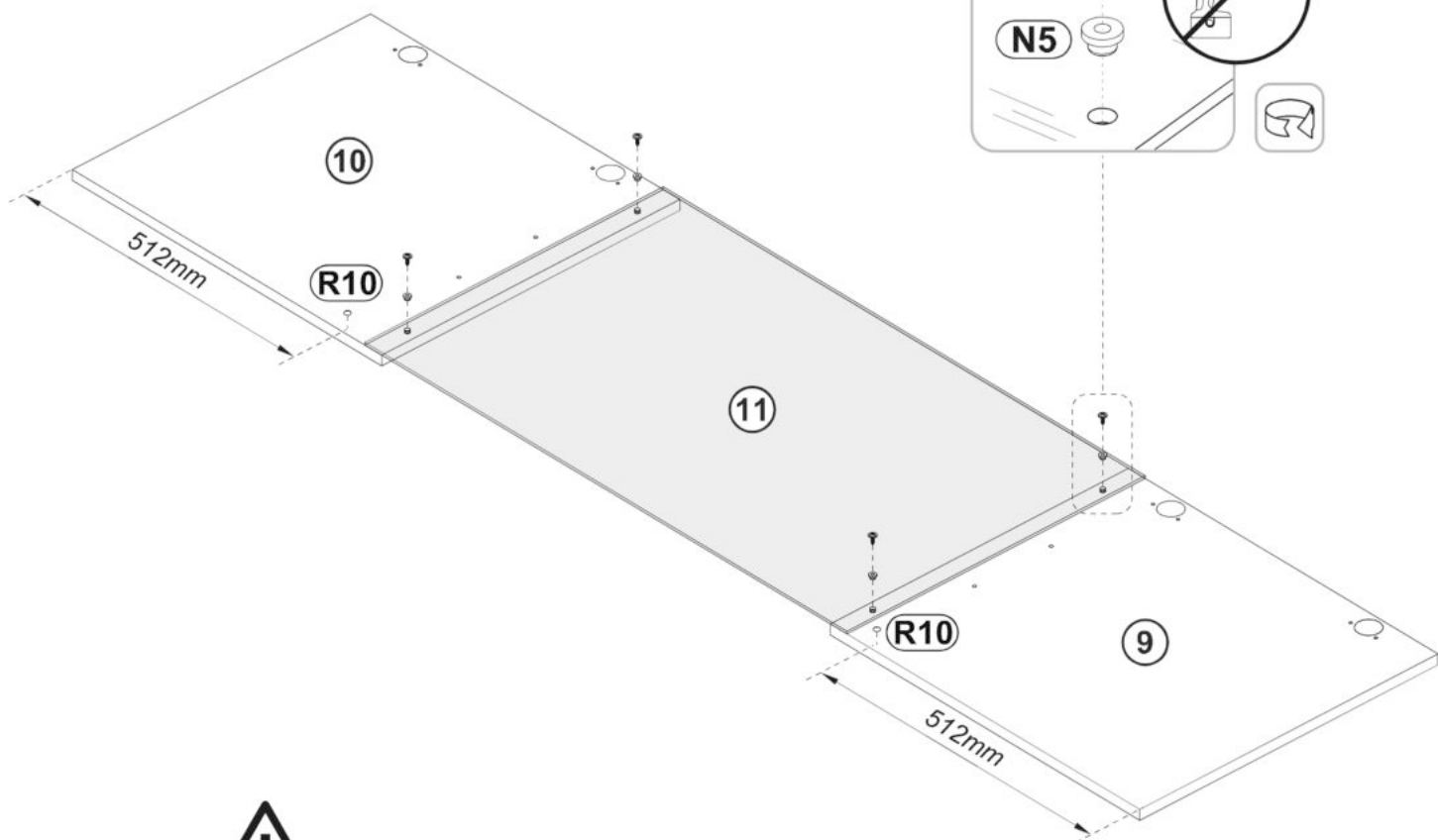

13

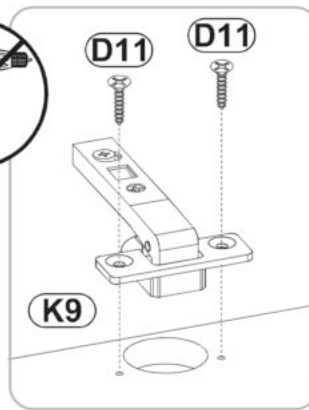
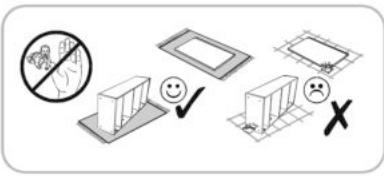

K9
Ø35 x4

D11
3,5x16 x8

DB2
4x25 x2

J65
128/148 x1

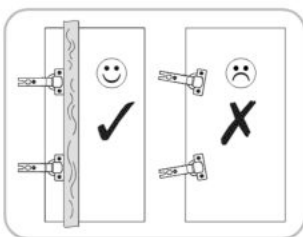
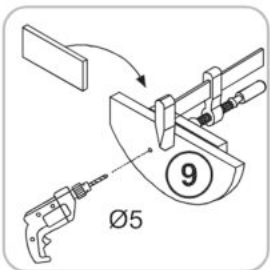
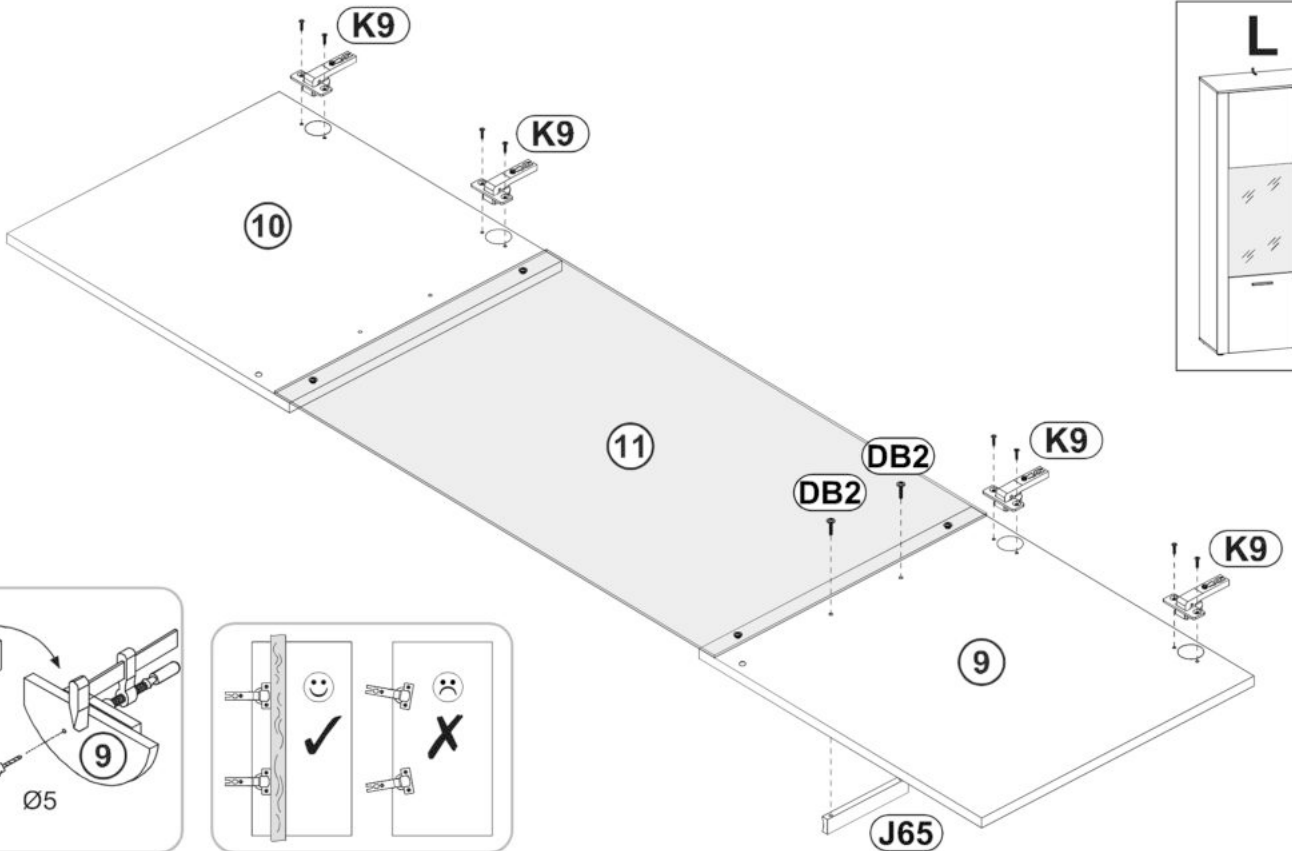
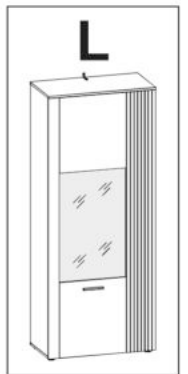
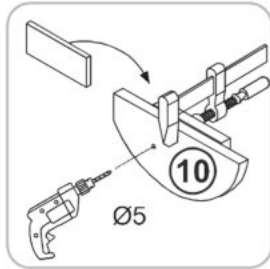
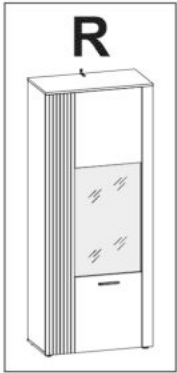
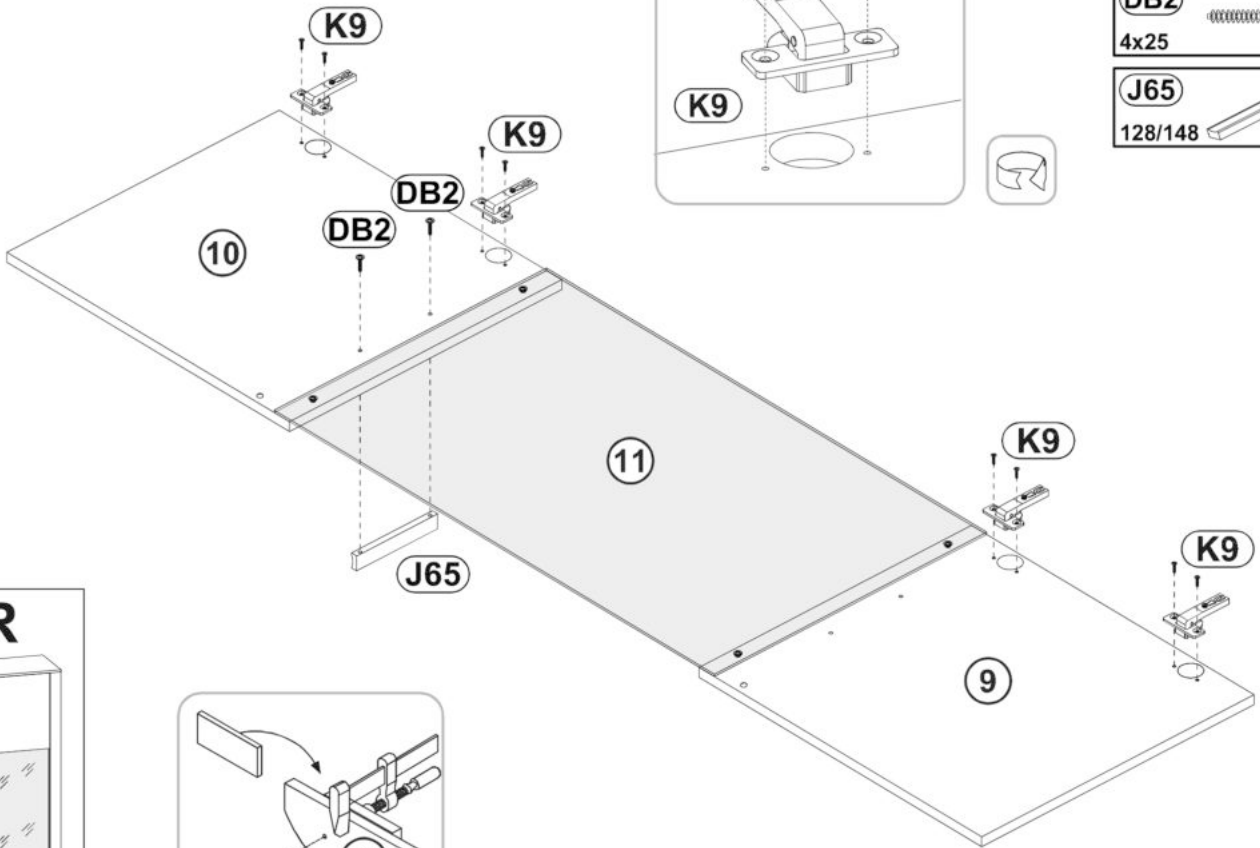

14

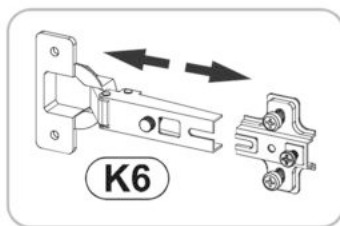
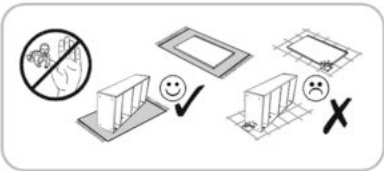

K6
Ø35  x4

DA21
4,2x16  x8

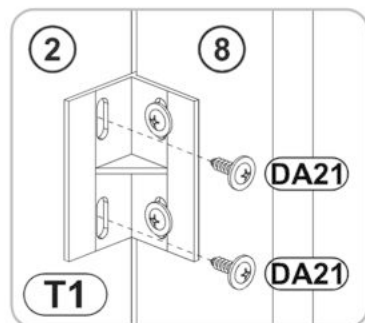
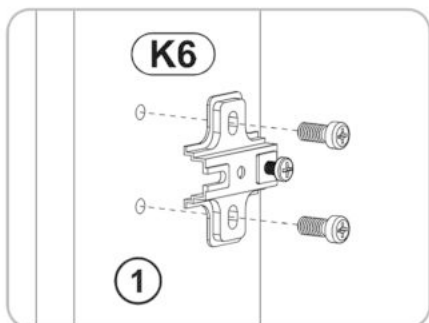
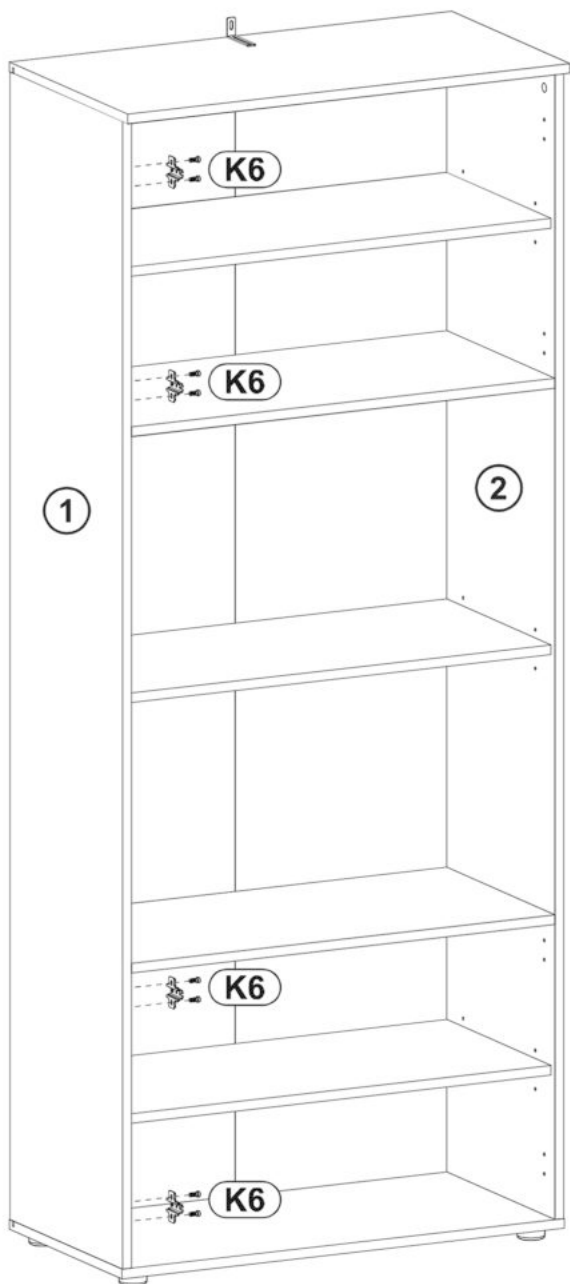
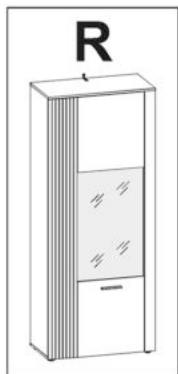

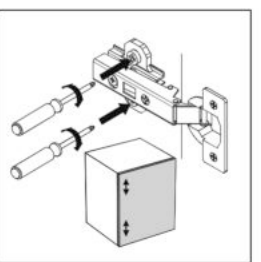
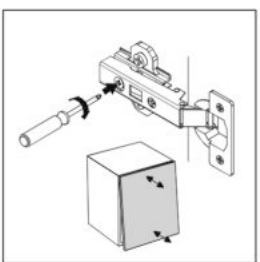
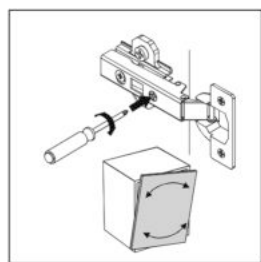
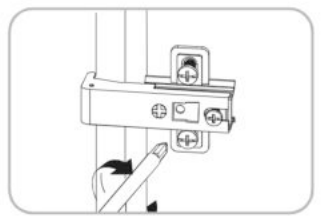
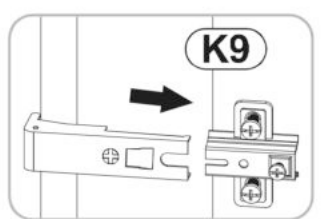
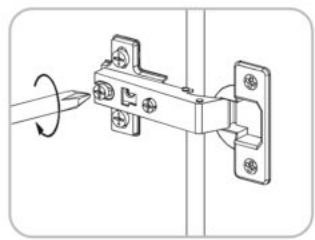
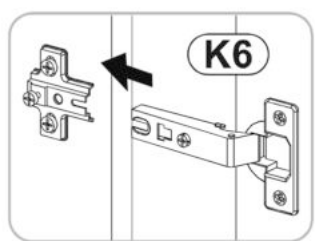
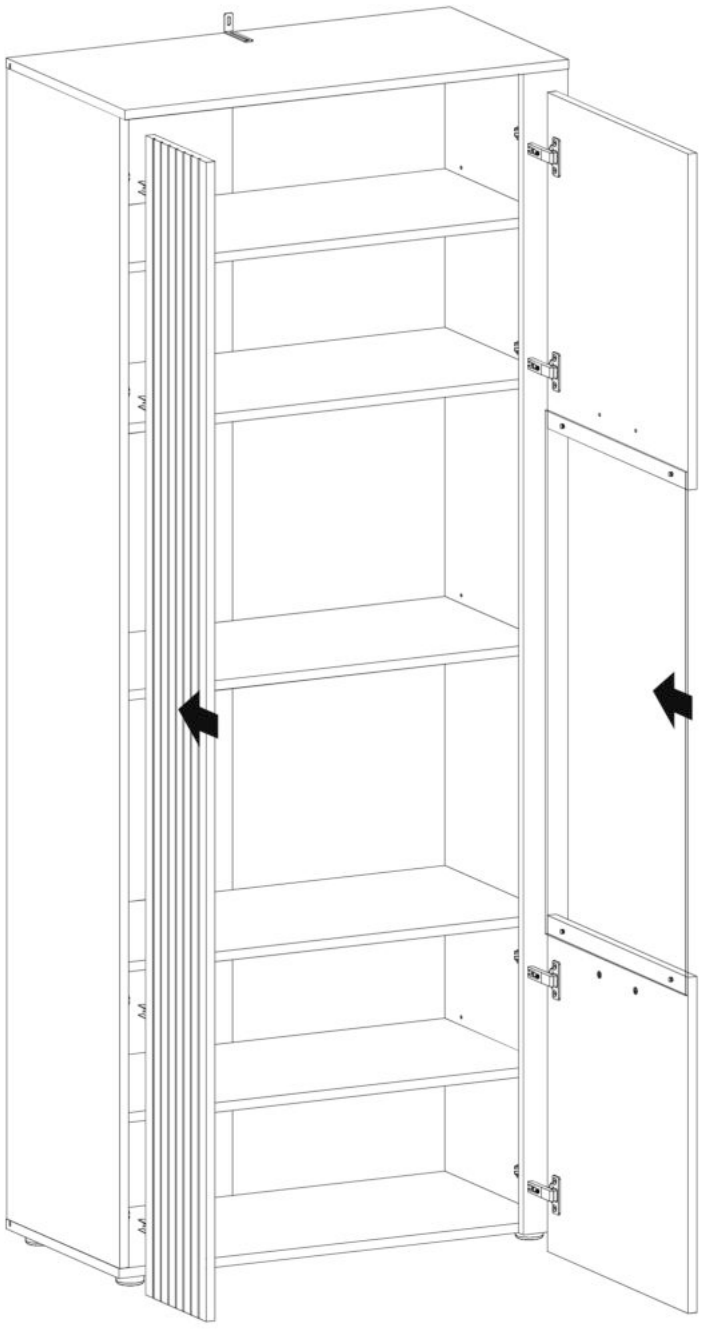
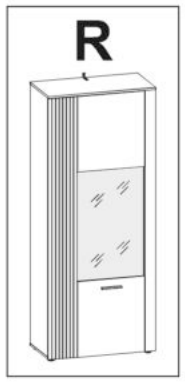
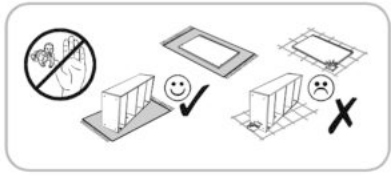

16

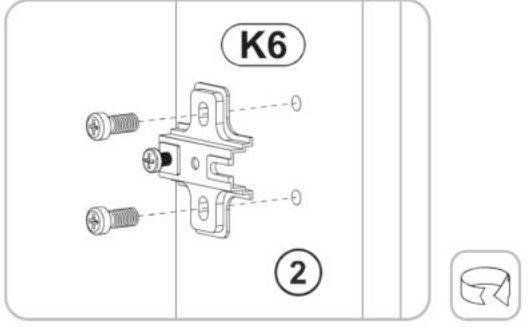
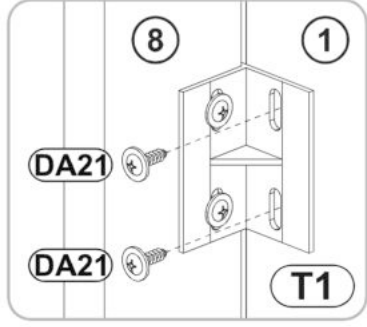
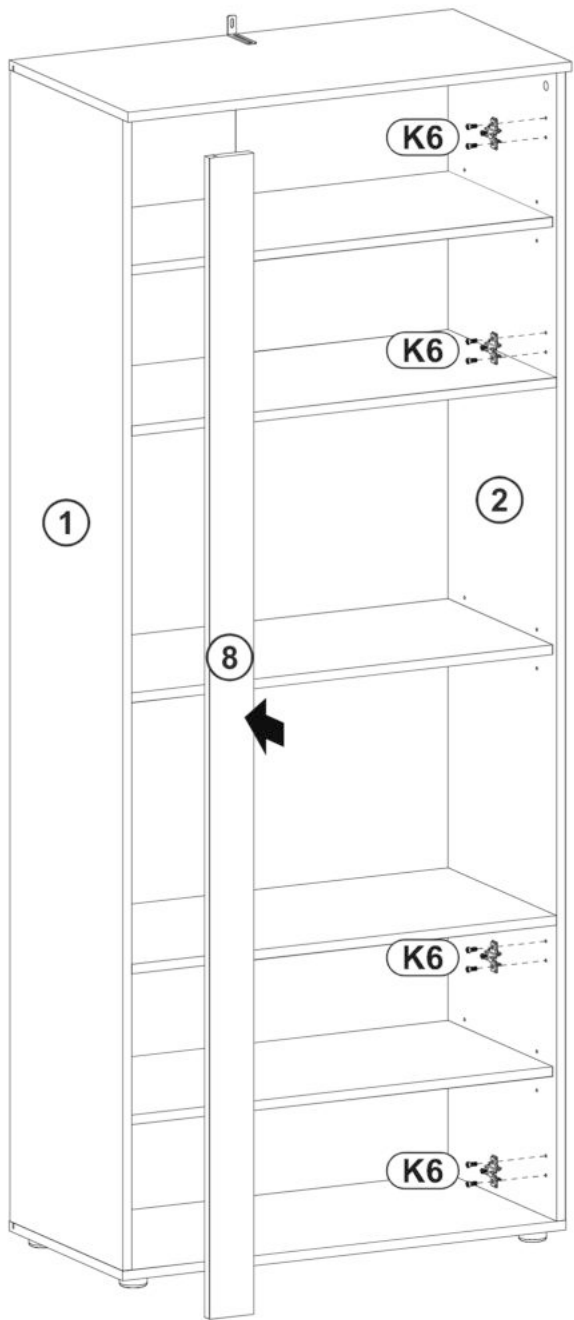
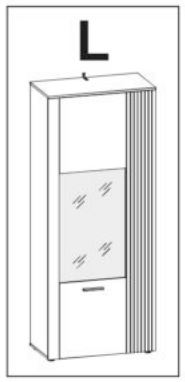
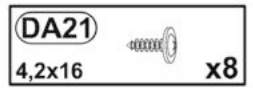
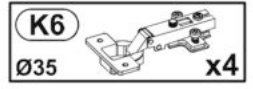
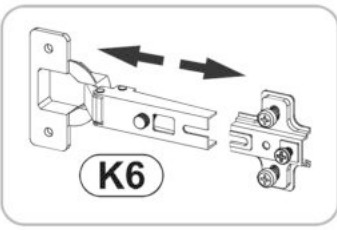
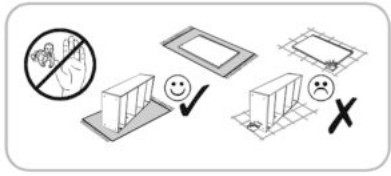

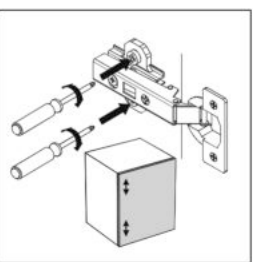
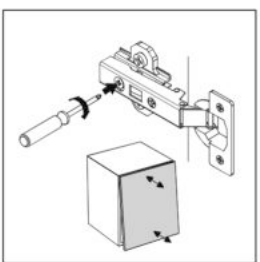
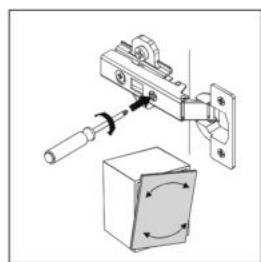
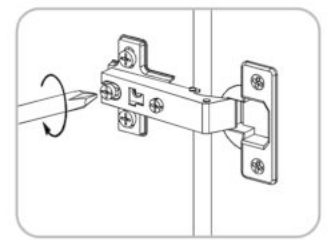
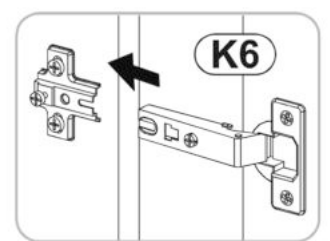
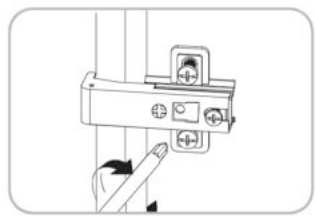
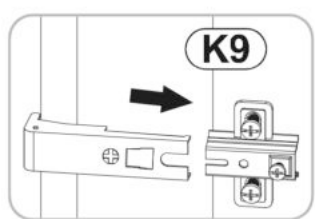
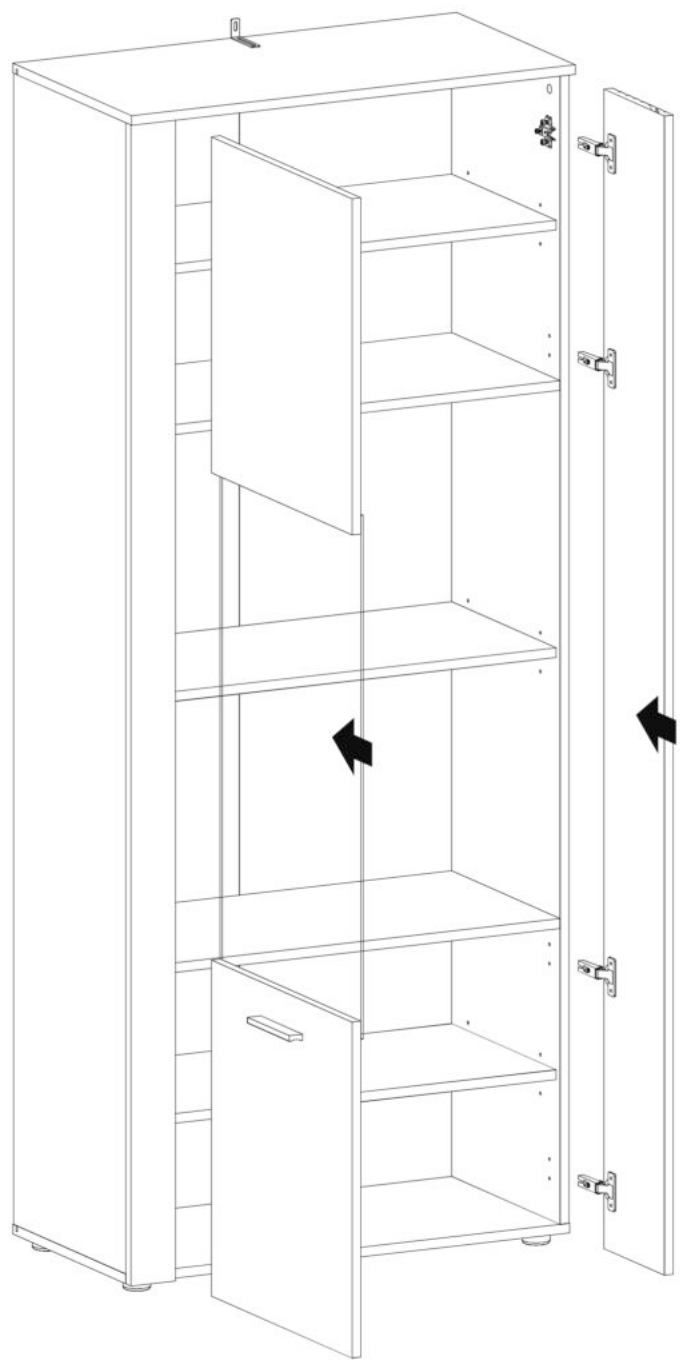
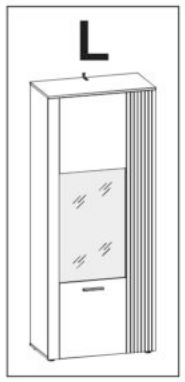
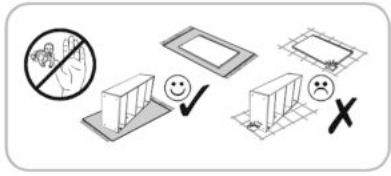



L

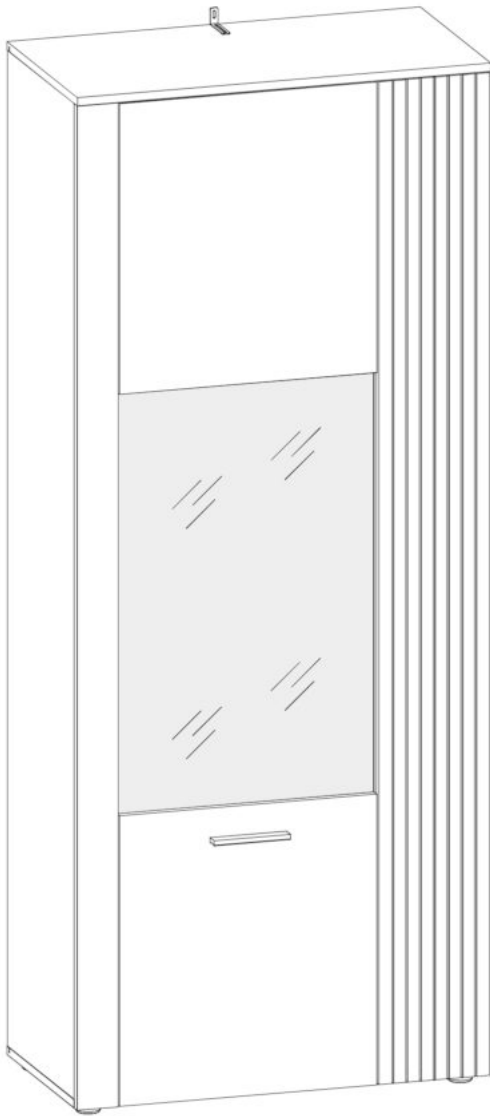

R

